

# Electronic Bidet

## KAI-WC24 Operating Manual

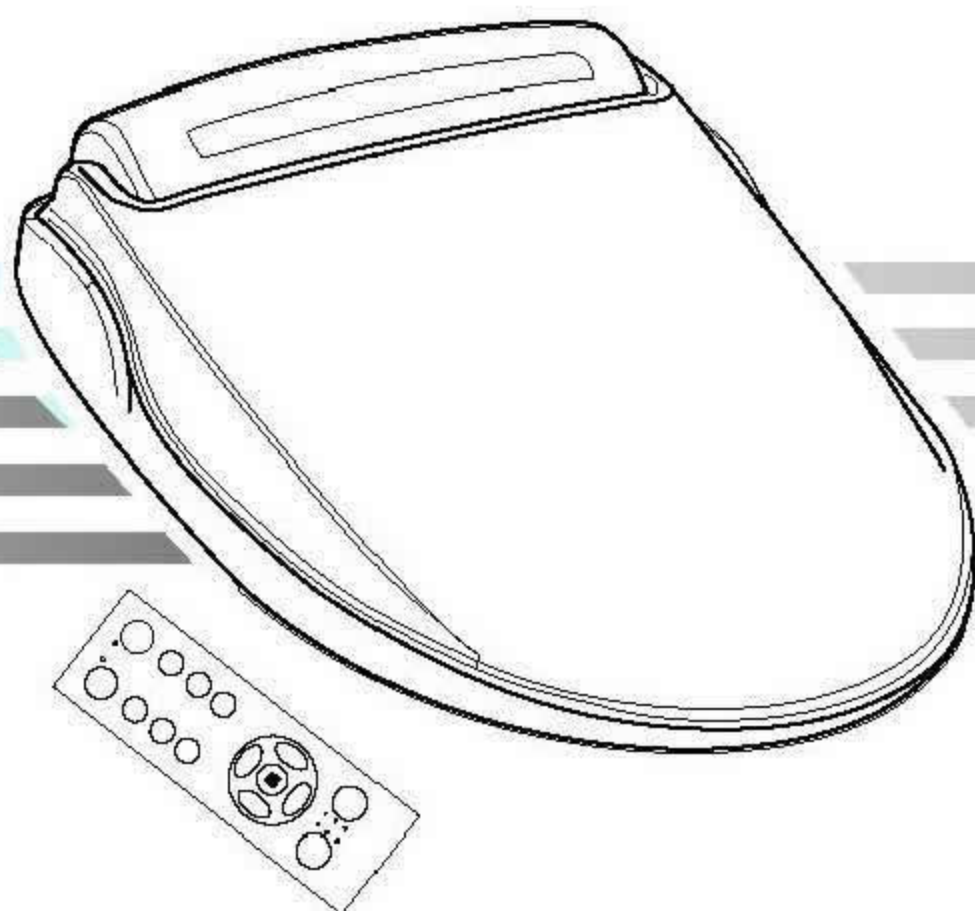

# Catalogue

① Safety alarm & Attention & Product characteristic .....	1	<b>Preparation</b>
② Product mix & name .....	5	
③ Basic usage .....	6	<b>Using method</b>
Functional regulation & the usage		
④ Installation methods .....	10	<b>Methods of installation</b>
⑤ Product disassembly .....	11	
⑥ Routine maintenance .....	12	<b>Maintenance &amp; the others</b>
⑦ FAQ .....	13	
⑧ Product specification .....	14	
⑨ Quality warranty .....	15	

◆ Please note: We reserve the right to amend and update the information contained in this catalogue with out prior notice.

# 1

## Safety Information

Please read carefully prior to installation or use of this appliance. Failure to comply with these instructions could result in loss and or serious injury.



**Warning !**

**DANGER.** It is mandatory to comply with the instructions. Repairs must only be undertaken by a trained qualified technician. Failure to comply may result in loss or serious injury



**Attention !**

■ Following is the indication chart.

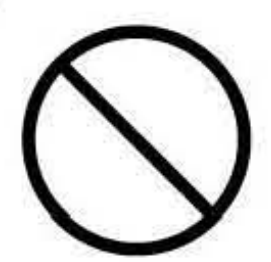

Prohibited.



General Prohibition.



Do not touch with wet hands



Do not incinerate.



Do not disassemble



No Water



Mandatory Items.



Mandatory Items.



Connect Earth



Warning



No disassembly

Do not disassemble, repair or modify this appliance.

- ◆ Doing so may result in fire or electric shock
- ◆ Please consult your sales outlet for any repairs

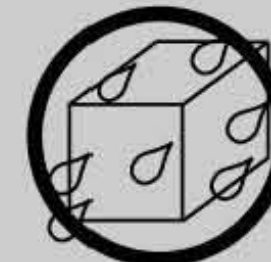

No water immersion

Do not pour water on the unit or use in a humid, un-ventilated environment

- ◆ Doing so may result in fire or electric shock



Connect the earth wire

This appliance **MUST** be earthed

- ◆ Electric shock and injury may occur if the unit is not correctly earthed and tested prior to use

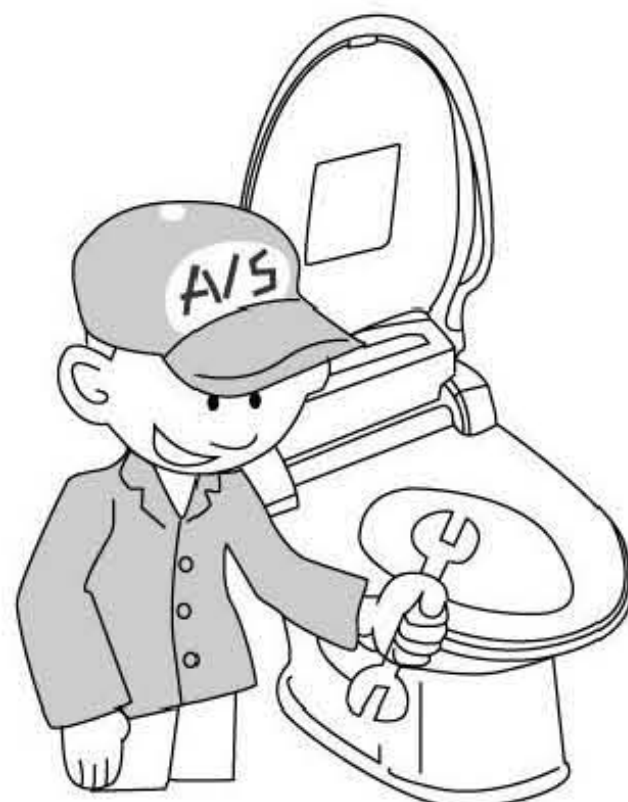

No touch by wet hand

In some countries it is permitted to connect the unit via a power plug, in this case never attempt to unplug the unit with wet hands.

◆

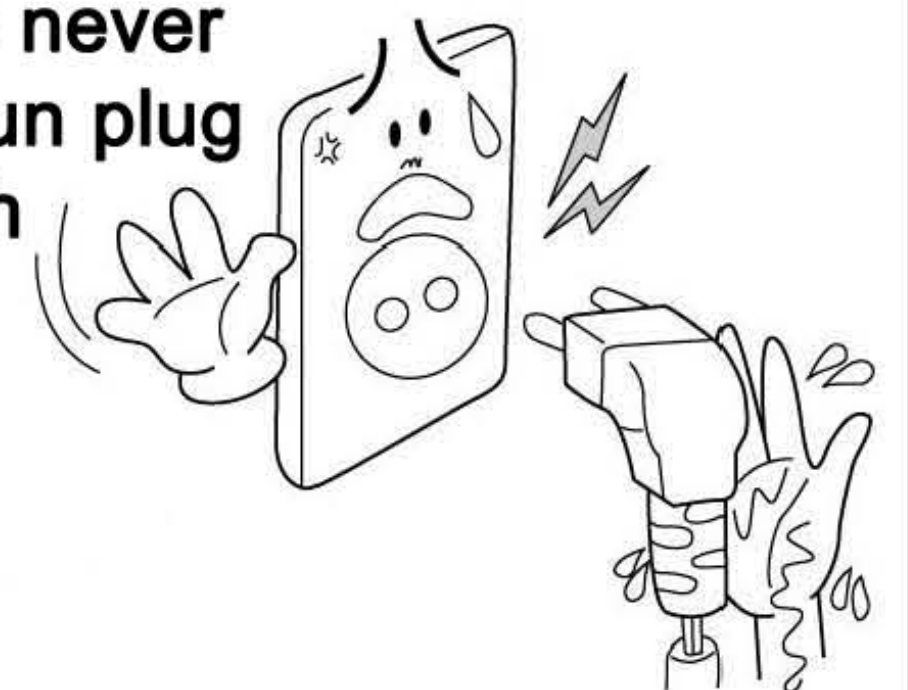

Prohibition

Do NOT connect the power until the unit is fitted in the correct position on the toilet and the water is connected and turned on.

- ◆ Doing so may result in fire and damage to the unit.



Prohibition

If your territory permits connection via a plug and socket, do not overload the socket.

- ◆ If permitted and using a plug ensure it is fully and firmly plugged in.

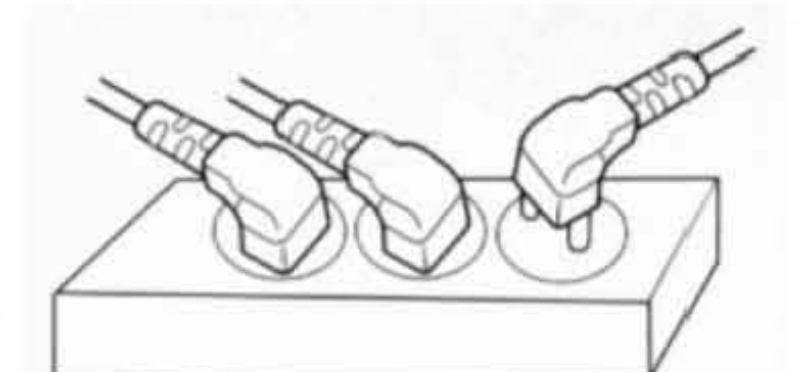

# 1

## Safety alarm & Attention Product characteristic

### Warning



It must be carried out

#### Attention low temperature burn

Low temperature burn maybe resulted if it contacts the skin in low temperature for a long time. The group of child, old, weak, sick and disabled can use it after adjusting the toilet seat temperature, water temperature and ovedried temperature (lower).

- ◆ Please adjust the water temperature lower after using the high temperature for old, weak, child and skin sensitive group.



Prohibition

Don't connect water source of industrial consumption except domestic water pipe.



- ◆ It may cause skin injury, dermatosis and product functional fault.



Prohibition

Don't use cleaner, benzene and diluent when cleaning product.



- ◆ It may lead the damage and broken of the product.



No close to fireworks

Don't put the burning cigarette or other conburent near the product or throw then into the toilet seat.



- ◆ It may cause fire.



It must be carried out

Please pull out the plug for safety when repairing or disassembling products.

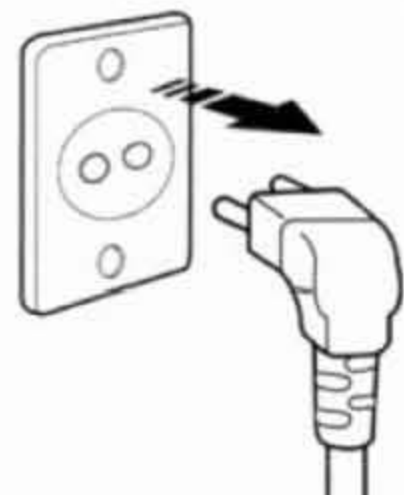

- ◆ It may cause creepage.



It must be carried out

Don't use damaged power sources, plug or outlet. Please contact service center to change the damage components in time.



- ◆ It may cause fire.



Prohibition

Don't step or stand on the enemator cover, especially don't sit on the cover.



- ◆ Don't step on the closetool cover, toilet circle and the other devices. It may break the product and result fault.



Prohibition

Don't continue using the faulty product.

- ◆ It may cause fire or electric shock accident to continue using the faulty product.
- ◆ Please contact our factory or maintenance station to do the maintenance.



Prohibition

Don't close the cover emphatically.



- ◆ It will have a screw loose.



Prohibition

Don't use hand or things to cover the warm-wind outlet.



- ◆ It will cause burn.
- ◆ It will cause fire or electric shock.

# 1

## Safety alarm & Attention Product characteristic



### prohibition



Prohibition

Don't pull or bend the connecting pipe.

- ◆ It will take leakage or without water supply.

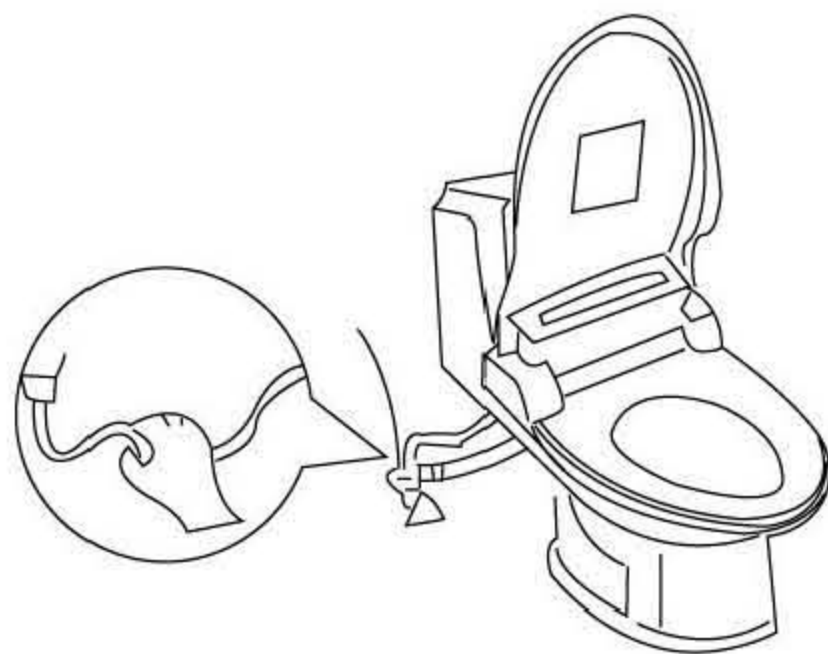

It must be carried out

Please take the product to be the special product. Don't use it in other purposes.

- ◆ It will take fire disaster, electric shock and injury.



It must be carried out

Pay attention not to bedew the urine on the warm-wind outlet and nozzle.

- ◆ It will cause stench and fault.
- ◆ Use soft toothbrush to wash if the nozzle is blocked by foreign bodies.



It must be carried out

Please pull out the plug and drain away the water in water tank if you don't use it for long term or when you clean up it.

- ◆ It will lead water modification and cause dermatosis.



## Product characteristic

- ◆ **Electricity conservation of artificial intelligence**  
The product has the function of power saving according to using period to set, which can help you to free from the electricity bill.
- ◆ **Omnibearing cleaning**  
In order to enjoy omnibearing cleaning you can move the nozzle from back and forth.
- ◆ **Strength water pump of low voice in the product**  
The strength pump of low voice in the product can ensure the superior function in lowwater pressure position.
- ◆ **Massage and cleaning function**  
The product with the function of massage for the automatic cycle can adjust the water pressure. It can use the strong and weak overlapping water pressure to improve the blood cycle.
- ◆ **Laxative function**  
The product has unique laxative function which concentrates water columns to play laxative function surprisingly.

- ◆ **Night lighting**  
When the environmental light is dark, the night light automatically turn on to provide soft lighting.
- ◆ **Adjust the position of nozzle**  
The place of nozzle, cleaning and catharsis can be adjusted back and forth according to user's body figure.
- ◆ **Use the inductive switch**  
The inductive switch will not start until sitting on the toilet seat. So it can avoid the accidentally start by children when they are playing.
- ◆ **Convenient installation**  
The product adopts mounting technique of separate type so that the installation and disassembly is simple and easy to be cleaned. You will not worry even if move often.
- ◆ **Deodorant function ( Except WN-970C )**  
The strong deodorizer in the product can eliminate odor after use.( except WN-970C )

# 2

## Product structure and name

### 1

#### Name of ontology

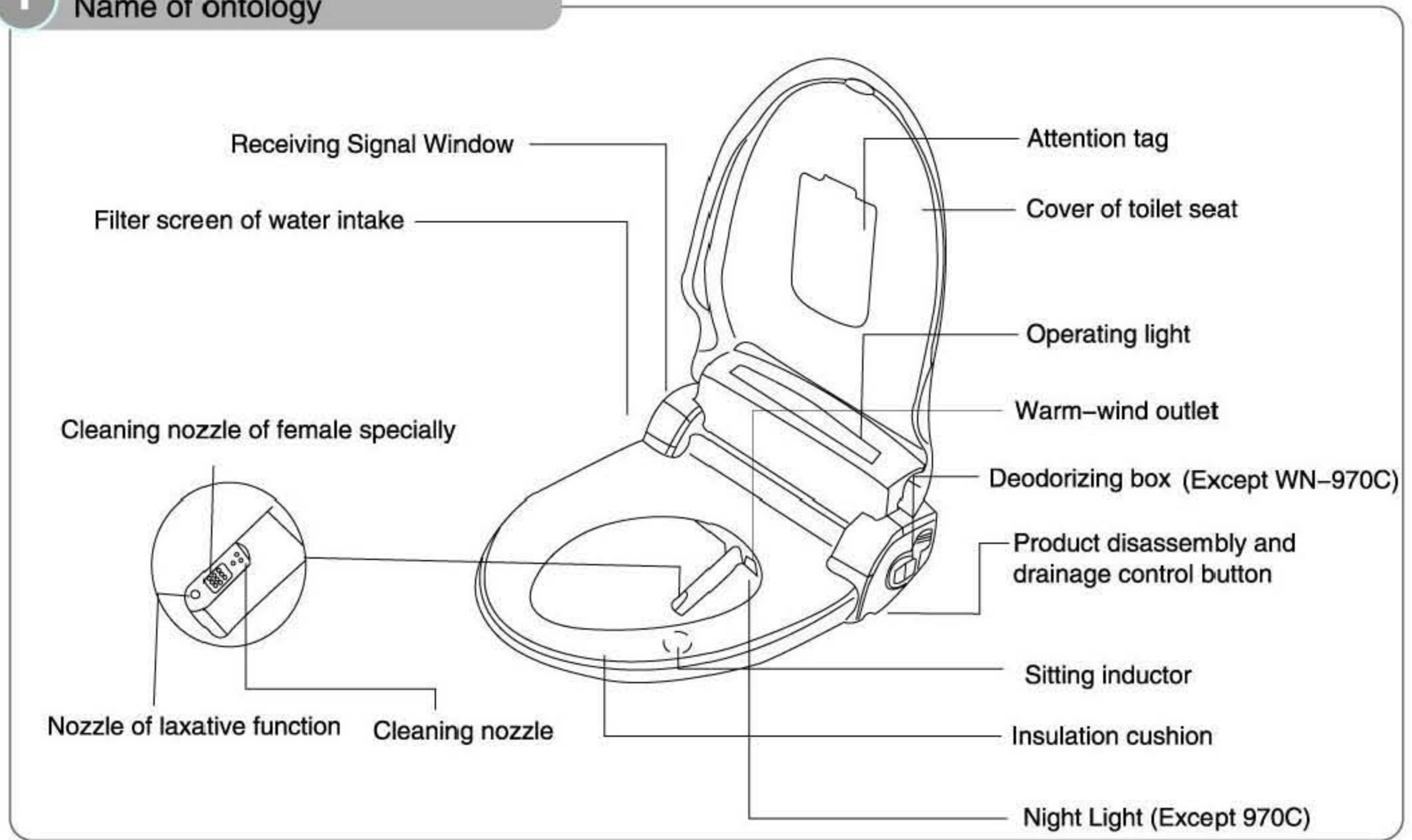

### 2

#### Accessory devices

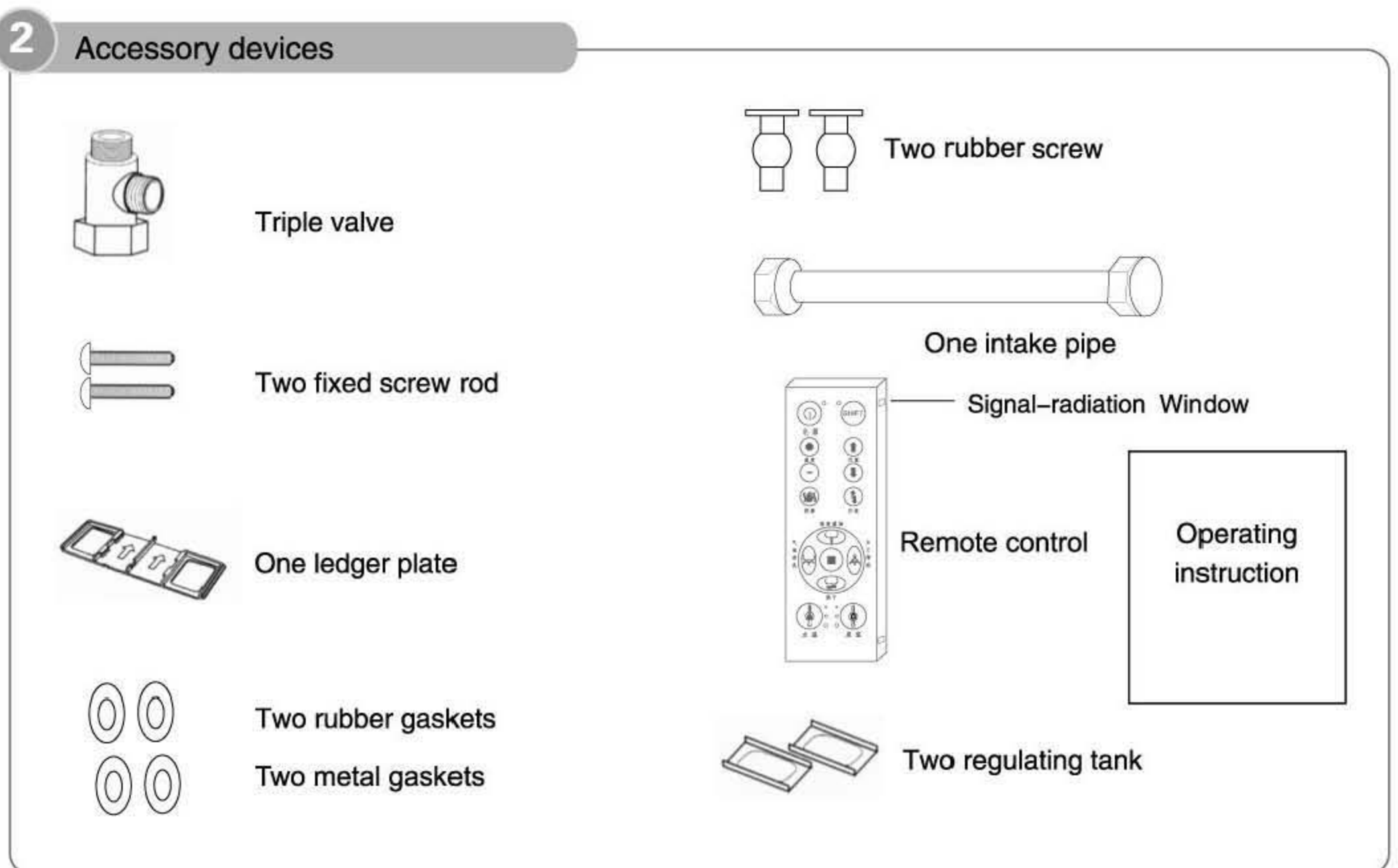

# 2

## Product structure and name

Work light indicator drop

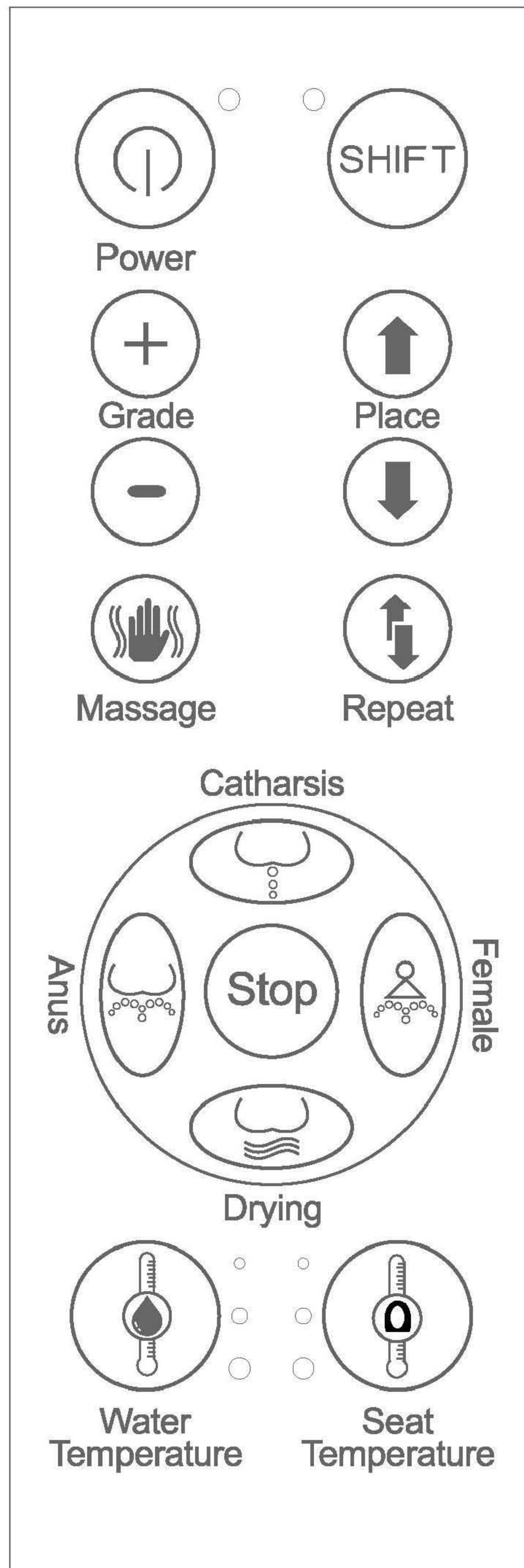

### ● Plug in the power

- ◆ Plug the power, after the flickering of the indicator light on the working light indicator board, you will hear a long ( Drip) sound, the machine is in standby status.
- ◆ Press the (Power) button on the remote control, the machine will send a ( Drip) short sound, at the same time the ( Power) indicator light will be on.

### ● Sit on the toilet seat

- ◆ When sitting on seat, sensor indicator light on the working light indicator board will be on, you can hear a ( Drip) at the same time, deodorization function will start automatically.
- ◆ If you left the seat, drying function will stop automatically after two minutes.
- ◆ Don't sit slantways toilet seat but sit in the center (the wrong sitting position will influence the normal operation of the induction switch and cause the irregular feed working of every function )

### ● Adjust water temperature

- ◆ Press ( Water Temperature ) button to adjust the water temperature, the water temperature indicator light will change circularly.

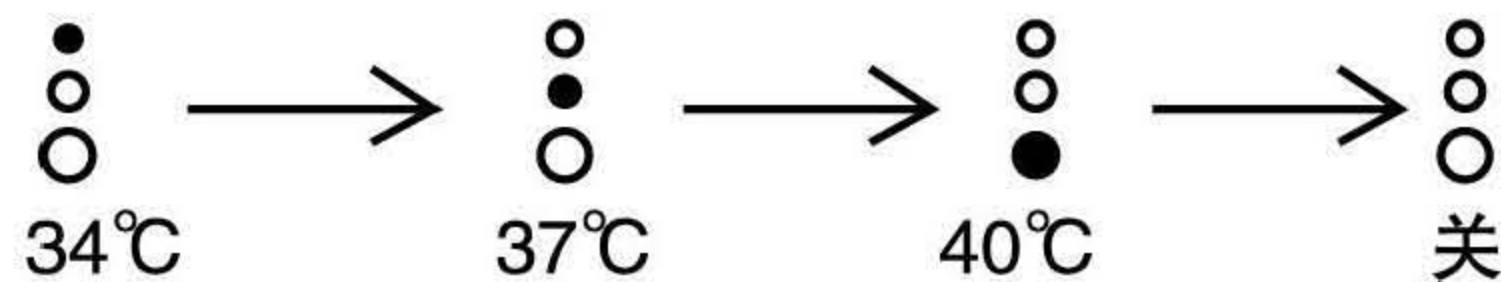

### ● Adjust the toilet seat temperature

- ◆ Press “Seat Temperature” button to adjust seat temperature. The seat temperature indicator light will change circularly.

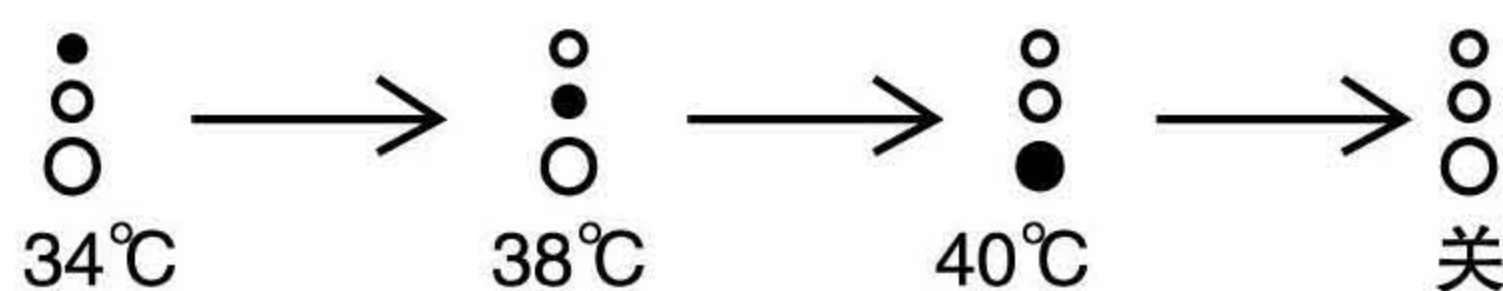

### ● Press (cleaning), (female cleaning), or (catharsis) button

- ◆ Respectively press (Washing), (Lady Washing) and (Catharsis) functions, each function will be started. Press (Stop) button, each function will be stopped.
- ◆ If you do not press ( Stop) button, each function will stop automatically after one minute.
- ◆ When leaving the seat, each function will stop automatically.
- ◆ The long-time working ( cleaning, catharsis and female special cleaning) will lower the water temperature. It must be stopped when the water become cold. The product can provide hot water about two minutes later.

### ● Adjust the water pressure

- ◆ You can press (⊕ or ⊖) of the pressure button respectively to adjust the water pressure when you use washing, lady washing and catharsis functions.



### 3



## Using method (Functional regulation & the usage )

### Adjust nozzle place

- ◆ When you use three washing functions you can press position button (  and  ) to adjust nozzle to move dolly.

### The correct usage of catharsis function

#### The first stage

Please press catharsis button to make watercourse to align the central anus when you use, and then use the "strength" Select button (  or  ) to adjust the increase or decrease of the water pressure.

#### The second stage.

After the water spray into the rectum and keep it in rectum for a while, and then exert yourself to eliminate the feces and exhaust gas.



Water column aims anus correctly

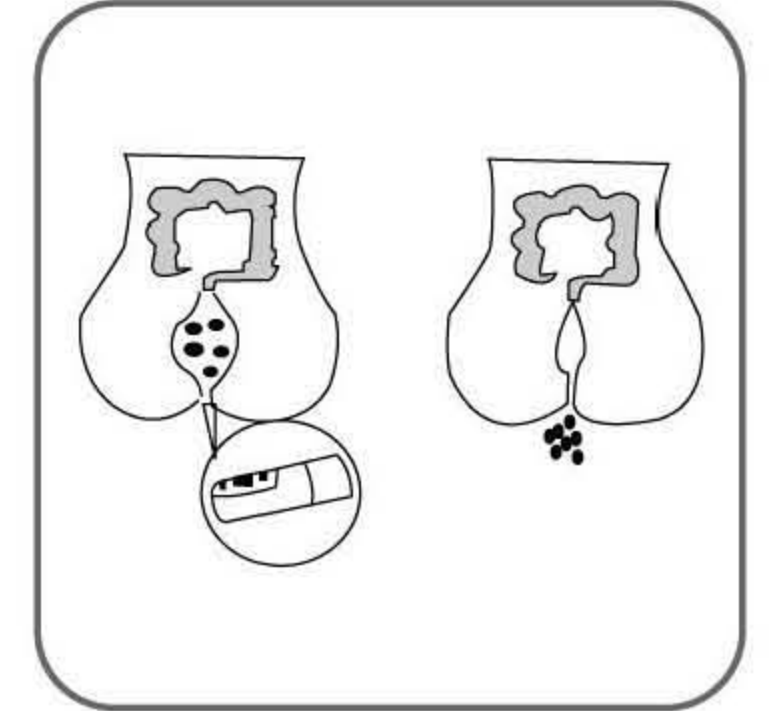

pouring in ... discharging





If the water column doesn't aim at the center of anus, you may feel pain and it will splash water.



The user, who is ill with anus diseases as hemorrhoids, has the phenomenon of haemorrhage or pain when beginning to use. But this phenomenon will disappear two – three days later.

### Press (dry) key

- ◆ Press (dry) button, drying function will start to work. Press "strength" button (  and  ) to adjust the increase and decrease of the warm-air drying temperature. Press "stop" button, this function will stop after two seconds.
- ◆ If you do not press (Stop) button, drying function will stop automatically after two minutes.
- ◆ If you left the seat, drying function will stop automatically.

### Massage clean

- ◆ Pressing (massage) button during the cleaning procession, the massage will be on in strong and weak alternative water pressure.
- ◆ When using massage function, press (massage) again, massage function will stop.

### Reciprocating clean

- ◆ The nozzle will shuttle and enlarge the cleaning scope when you press the (reciprocation) button in cleaning process.
- ◆ It will stop moving if you press (reciprocation) button once again when it is moving.

### Power saving

- ◆ The temperature of the water and seat will be kept in 32 centigrade if without using in 12 hours.
- ◆ It will automatically turn off if without using in 24 hours.

# 3

## Using method

### Automatic Night Lighting Function

- ◆ When the environmental light is dark, the night light automatically turn on to provide soft lighting.

### Automatic Deodorant Function

- ◆ When someone seated, the deodorant function automatically open. When people leave for two minutes, deodorant function will be closed. If you do not want to use deodorant function, please press "shift + temperature" button when nobody is sitting on it, when hearing a long "Drip" sound, the deodorant function will be closed. For open automatic deodorizing, press "shift + temperature" when nobody is sitting on it, when hearing a short "drip" sound, the deodorant function will be open.

### Automatic Reciprocating Function

- ◆ Press "shift+repeat" button when nobody is sitting on it, after hearing short "drip", automatic reciprocate function is open.
- ◆ Press "shift+repeat" again, after hearing long "drip" sound, automatic repeat function is closed.
- ◆ When automatic repeat function is open, when you use "washing" and "lady washing", repeat function will be open autoamtically.

### Automatic Massage Function

- ◆ When nobody sitting on the seat, press "shift+massage" button, after hearing short "drip" sound, automatic massage will be open.
- ◆ Press "shift+massage" again, when hearing long "drip" sound, automatic massage function will be closed.
- ◆ When the automatic massage function is open, when using "washing", "lady washing" and "catharsis", massage function will open autoamtically.



### Attentions before installation

- ◆ Before installation, please check the if the voltage of this product conforms to the local voltage.
- ◆ Before the installation, you can not connect the power absolutely.

1

Close feed valve  
Close feed valve and empty the water tank.

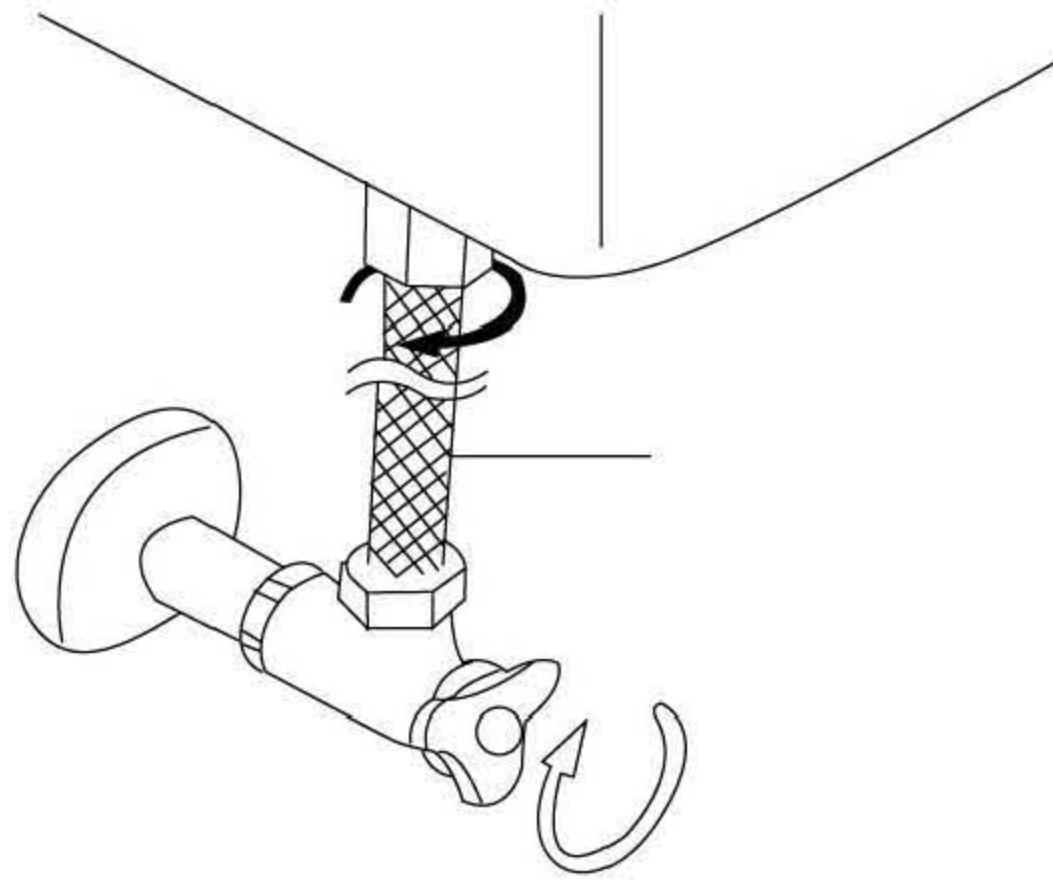

Use spanner to dismantle the original potable water pipe which connects the feed valve.

2

Dismantle original closetool cover



Unscrew the screws which fixes the closetool cover. Dismantle the closetool cover as the picture.

3

Install the triple valve

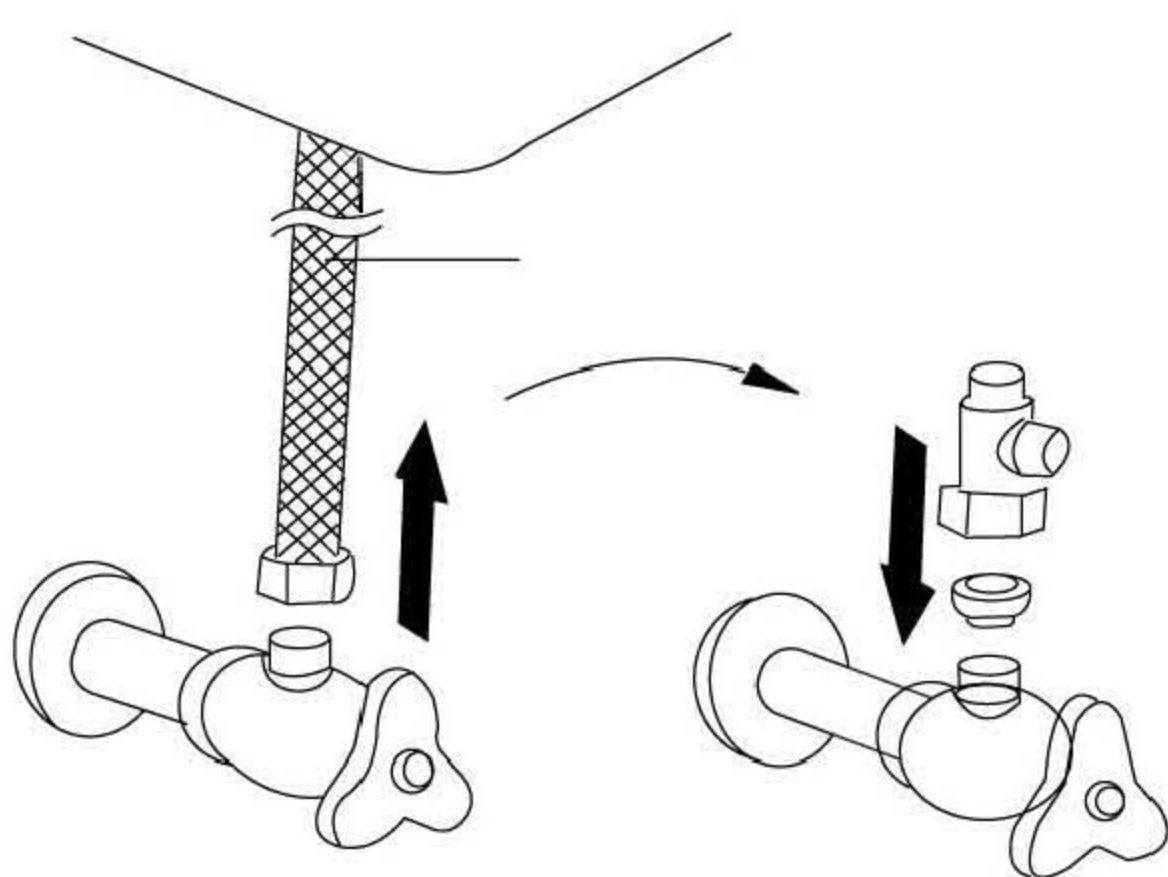

Install the triple valve as the picture.

4

Connect the potable water pipe  
with water tank.

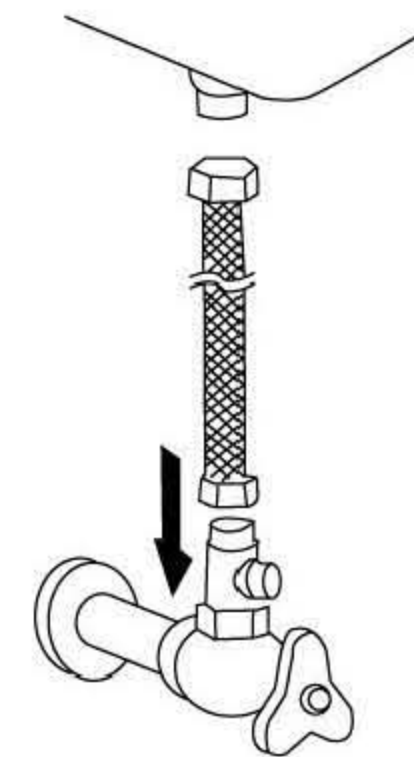

Use original potable water pipe to connect the triple valve and water tank respectively.

5

Install rubber screw



Put rubber screw in hole and then compress it

6

ledger plate



Screwing the stainless steel bolt into rubber bolt hole by passing through the adjustment slot

# 4

## Methods of installation.

### 7 Regulate and fix bidet

slide bidet into the groove until locked

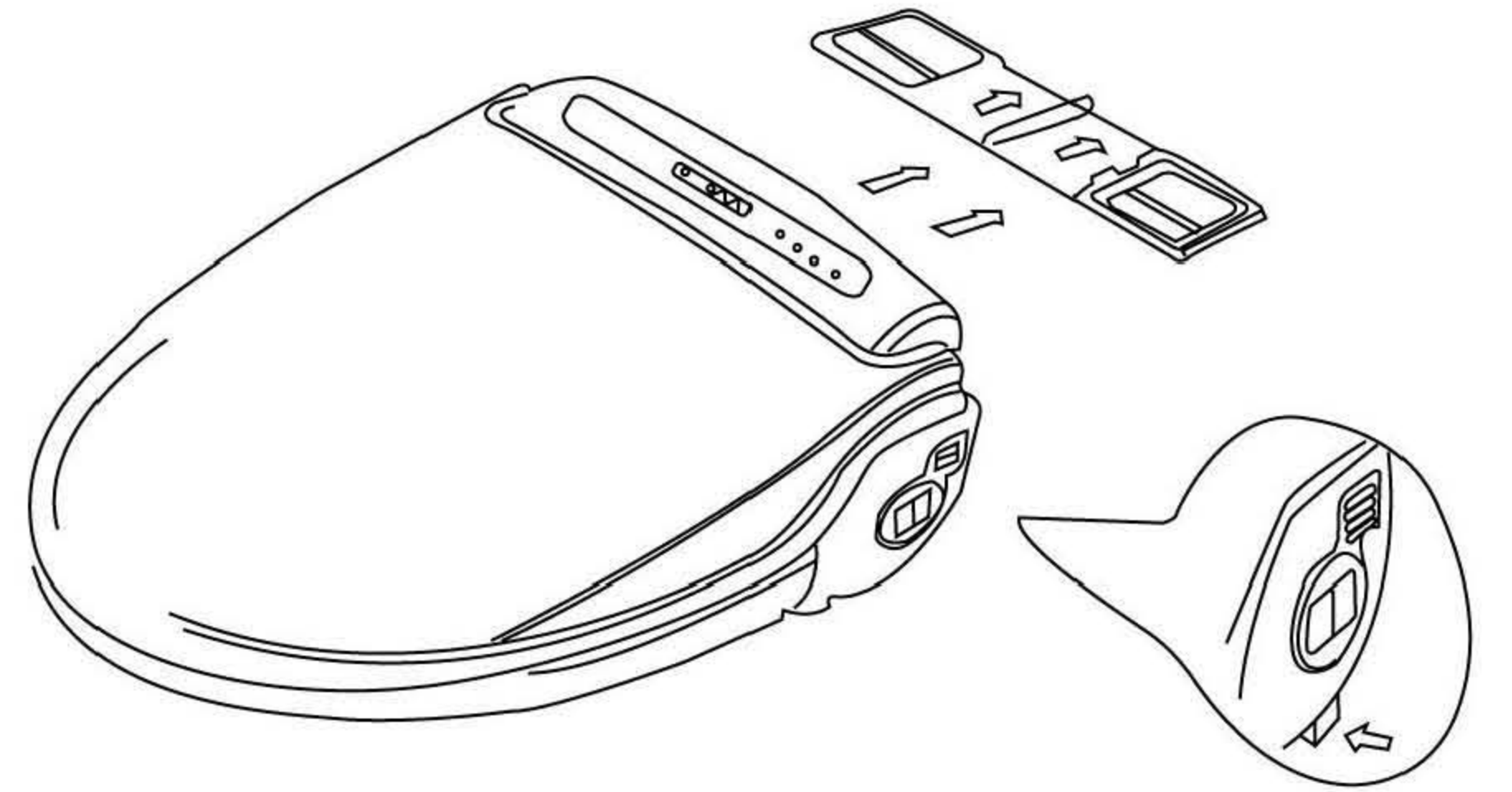

### 8 Switch the water hose in bidet

- \* Connect one end of the water hose to the three-way valve.
- \* Open the inflow valve faintly to make the water out flow from the water hose, then close the inlet valve.
- \* Connect the other end of the water hose to the bidet as the picture.
- \* Open the inflow valve.
- \* Plug in the power , press the "Power" button, the power indicator light on the working light indicator board will be on, at this time the water tank will start inflow. Start water. The “heating” indicator light on the working light indicator board will flicker during the inflow and accompanied by ticktack tweet, when the flicking and tweet stops, it indicates that the water tank has finished the inflow.
- \* The installation of bidet is off. Welcome to use it.

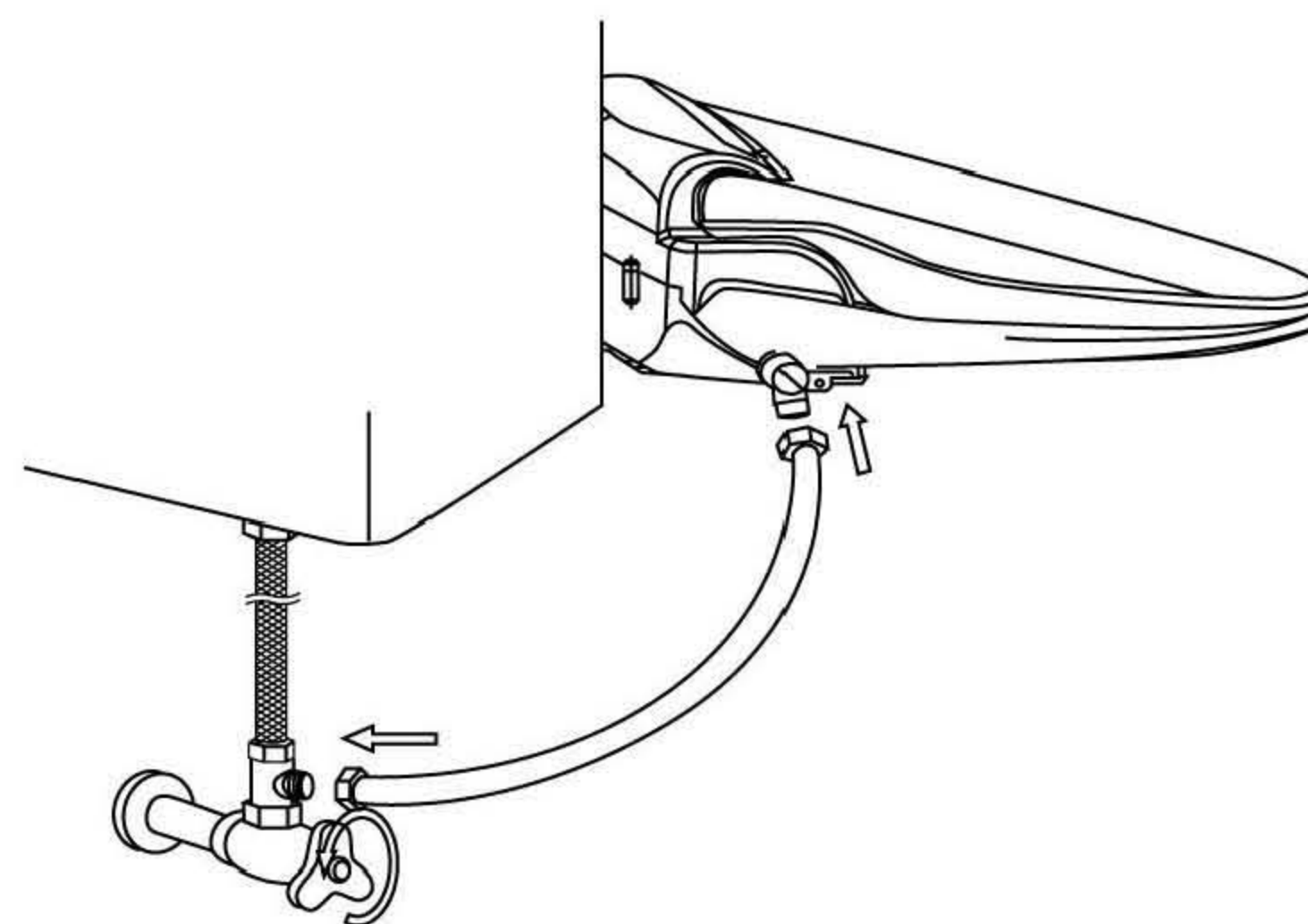

# 5

## The dismantlement of product

When you have to disassemble the machine because of moving house and clearing, please follow the next steps;

- 1 Pull out the power plug.
- 2 Cut off the supply valve in clockwise direction .
- 3 Press on the side of the drainage button, completely remove the water in the storage water tank.
- 4 Pull the toilet seat slightly, in the meantime press the sided fixed button of the machine(arrow), that will make the machine separate from the ledger plate.

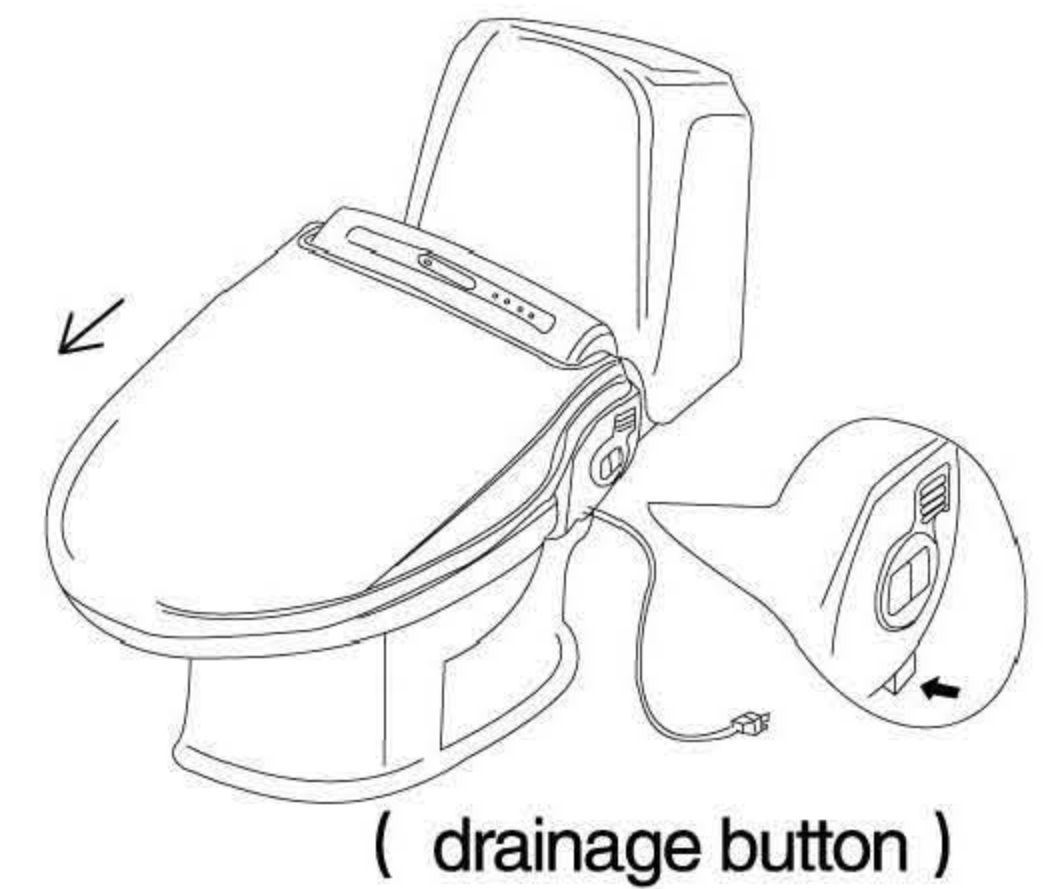

Continue to pull backward to let the machine separate from the closetool.

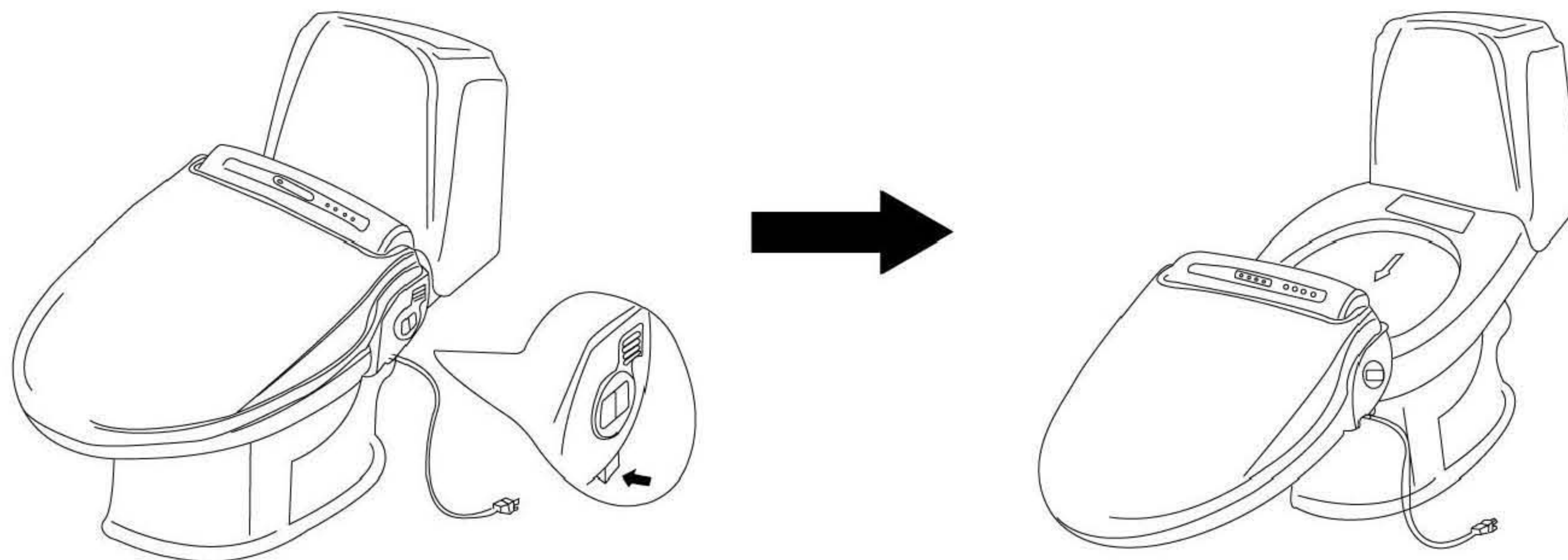

Untie the water pipe which is connected the machine and disassemble water-nurse according to the next steps.

- 5 Separate water pipe and triple valve of bidet and closetool.
- 6 Connect the undone feed pipe when installing bidet and turn on the supply valve in anticlockwise direction. Be assure that there is no leakage in the part of feed pipe.
- 7 Please disassemble bidet and cover before installing electronic toilet seat .

The four items above are the disassembled method as general clearing. The following seven items are the disassembled method of moving houses, etc.

### Manual cleaning nozzle

- ◆ The nozzle will stretch out if pressing ( shift+washing) button ( don't sit on bidet at this time).
- ◆ Press ( shift+washing)button and nozzle will return to original state and clean automatically after brush it by toothbrush.

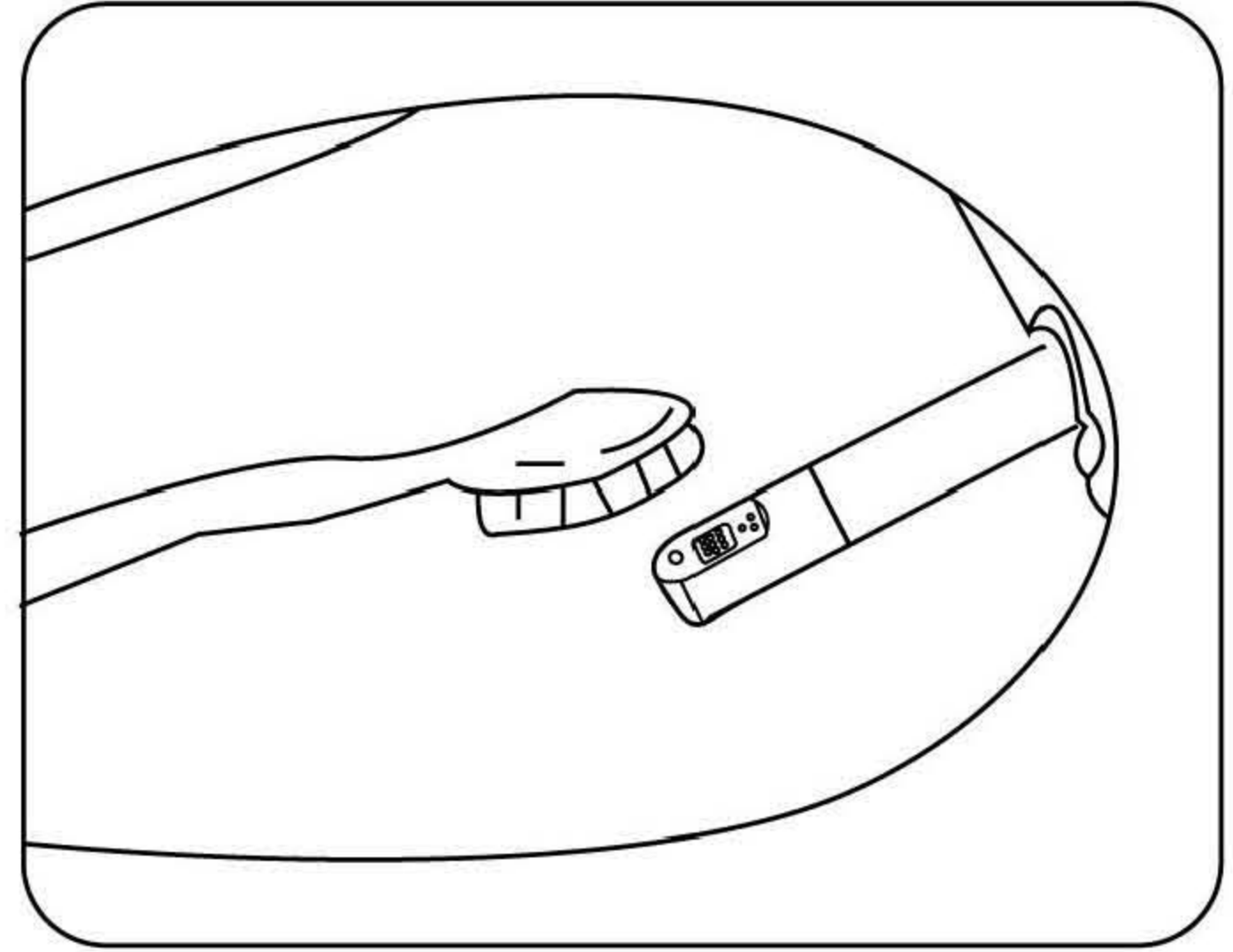

### Clean inhalant siphon filter

- 1) Close the supply valve first.
- 2) Rotating filter end cover counterclockwise, washed with water and then restore it. At last screw the end cover clockwise.

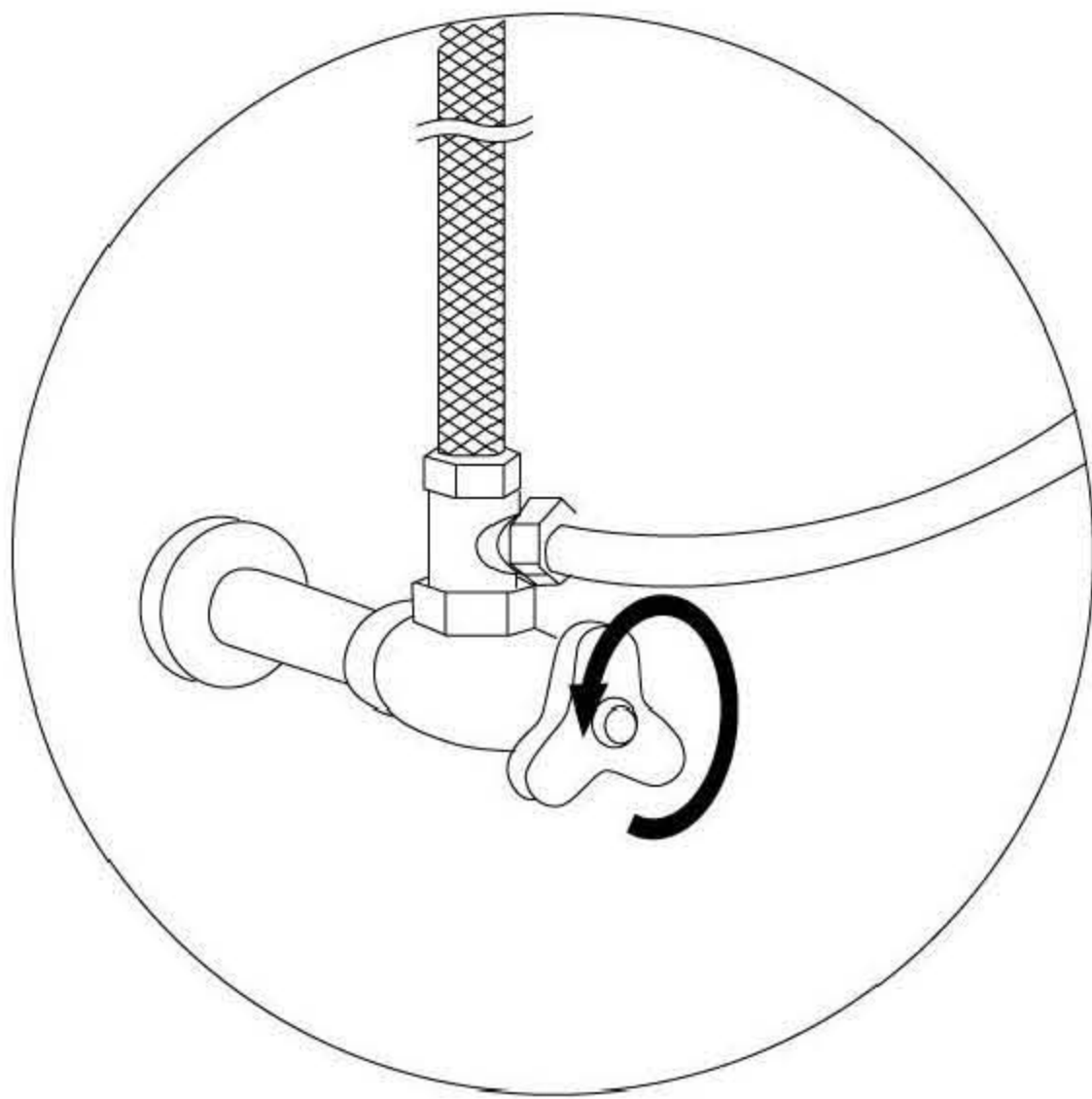

(1)

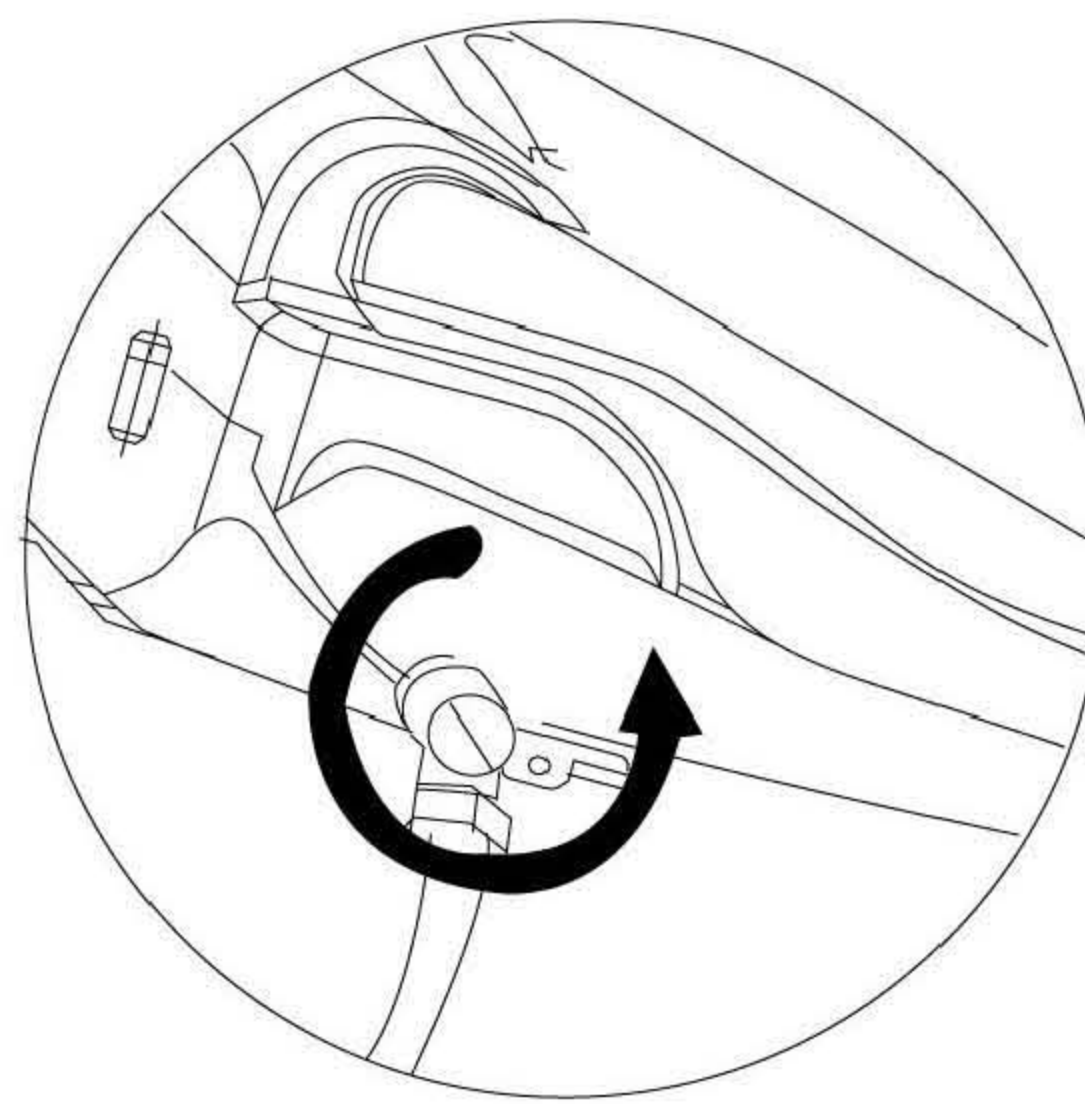

(2)

### Check the following items before consigning maintenance service

Condition	Possible reason
The nozzle can't spray out water.	Temporary water failure The water valve has been closed; The water filter has been blocked;
Inoperative state	Don't switch the plug well. The "Power" button of the remote control is not open The toilet seat will do not work if you do not sit on it.
Leakage	Triple valve of water duct chain is not in good toilet seat has't been inster closely and locked(need hearing "Clatter"sound) water filtering net blocking;
Under pressure	Adjust the water pressure,according indicator light. check if the filtering net is blocked
Water temperature, toilet seat and the drying is not hot enough the drying is not hot enough	Check the every temperature setting.
Buzzer alarming	Water tank is shortage of water Check whether the inflow valve has been open Check whether the water supply has been cut off Check whether the water pressure is too low or the filter has been blocked

Service voltage	<input type="checkbox"/> AC110V <input type="checkbox"/> AC220V 50HZ/60HZ
Electric power consumption	<input type="checkbox"/> AC110V 660W <input type="checkbox"/> AC230V 720W
The length of power source	1.7M
The scope of water pressure	0.4–4.5 Kgf/cm <sup>2</sup>
Product size	495mm ( W ) *480mm ( L ) *185mm ( H ) 495mm ( W ) *525mm ( L ) *185mm ( H )
Weight	5.5kg /6.0kg
Installation accessories	T-junction, soft permeable pipe, threaded rod, washer
Anus cleaning	0.9 every minute
relax the bowels forcefully	0.8 L every minute
female cleaning	0.8L every minute
to and fro cleaning method	12mm move the nozzle fro-to-back during the scope of 12mm
the cleaning method of massage	strong-and-weak water column
the control of nozzle place	adjust front and back freely
the control of water pressure	water pressure of five adjustable states
water temperature control	four adjustable state ( normal, 34 centigrade, 37 centigrade, forty-one centigrade)
volume of water tank	1.4L
the heating power of water tank	600-watt
safety device	water temperature inductor, overheat production, temperature fuse
electric consumption of drying	250-watt
drying temperature	five adjustable state
drying security	temperature inductor, overheat production, temperature fuse
the electric consumption of temperature toilet seat.	fifty-watt
the temperature control of toilet seat	four adjustable states: normal 34 centigrade, 37 centigrade, forty-one centigrade
the toilet-set security	temperature inductor, temperature fuse
the delaying device	soft-land toilet seat



# Quality Warranty

Thank you for purchasing our products, we promise to safeguard your right as the followings:

If you find any quality problem about our products, please contact purchase place or contact our After-sale Service Department directly.

Production No.	Item No.	WN-990 ( ) <input type="checkbox"/>	
		WN-990 ( ) <input type="checkbox"/>	
Purchasing Date	Installation Date		
Signature of Service Staff	Hotline		
Term of Warranty:	Within one year from the date of purchase		
Maintenance Record	First Time	Second Time	Third Time
	Date:      Signature:	Date:      Signature:	Date:      Signature:
	Forth Time	Fifth Time	Sixth Time
	Date:      Signature:	Date:      Signature:	Date:      Signature:

## Items of the quality warranty

Please fill in the product warranty carefully when you buy this product and safekeeping it.

If the product is out of order during the warranty period and under normal use situation, We will maintain for free.

The charges which is collected in maintainance period but belongs to paid service is as follows:

Maintenance fee + Accessory fee + Travel allowance

## paid maintaince services

Fault caused by not operate according to the instruction

Faults because of unauthorized disassembling or remodeling

The maintenances which are caused by some disasters such as fire disaster, gas, flood, earthquake, thunders, ect and abnormal voltage.

Fault caused in the transportation

Move the machine to another place to install according to client's request.

Warranty period has expired

The service life of consumptive part is over( such as rubber gaskets, filter, deodorization ect).

